

# PIRATE RADIO

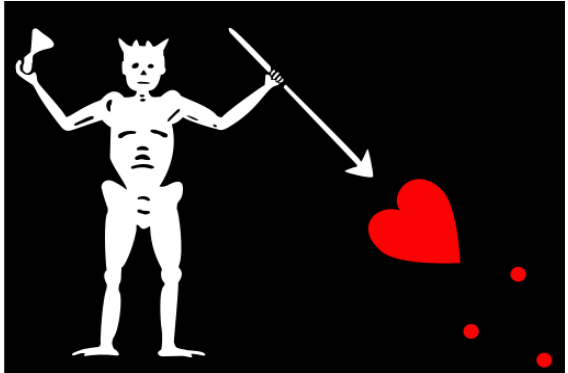

# Radio History

## James Maxwell

13 June 1831 – 5 November 1879



**INDUCTION IS ELECTRICITY FLOW AT A DISTANCE.**

[Michael Faraday](#) is generally credited with the discovery of induction in 1831, and [James Clerk Maxwell](#) mathematically described it as [Faraday's law of induction](#).

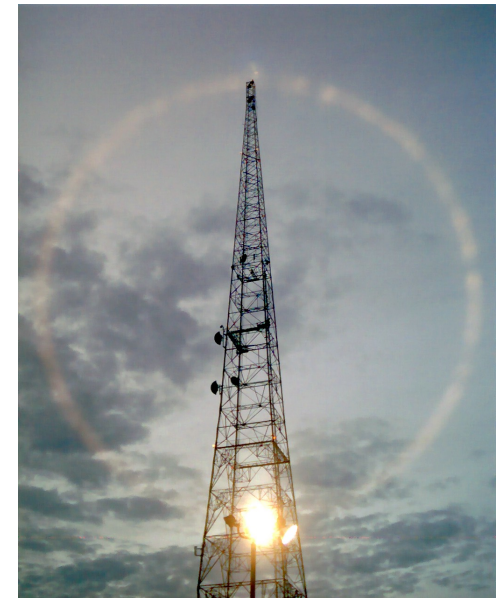

# Electricity

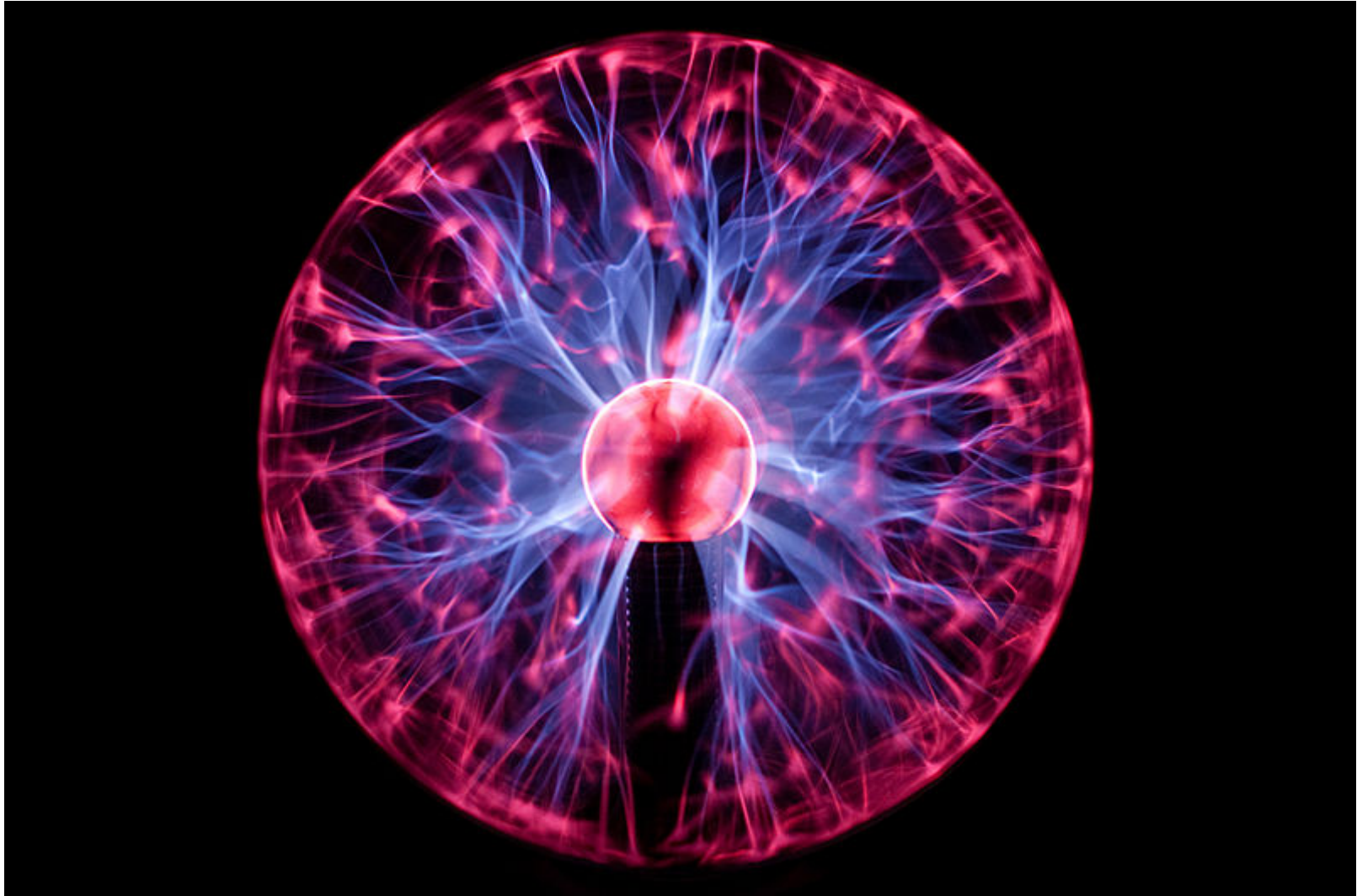

# Voltage AC/DC (VOLTS)

VOLTAGE

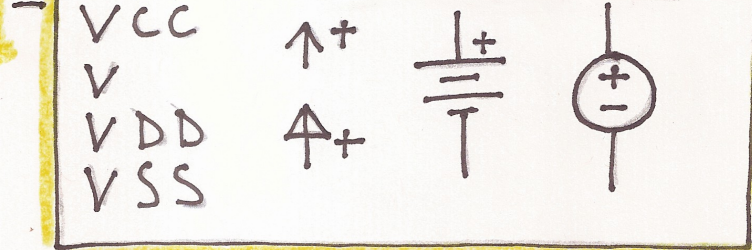

: Is The Electrical  
pressure between  
two points.

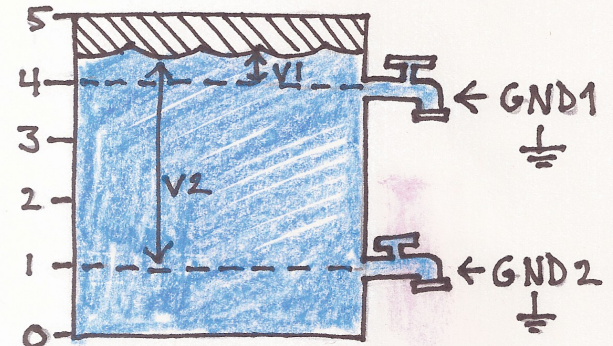
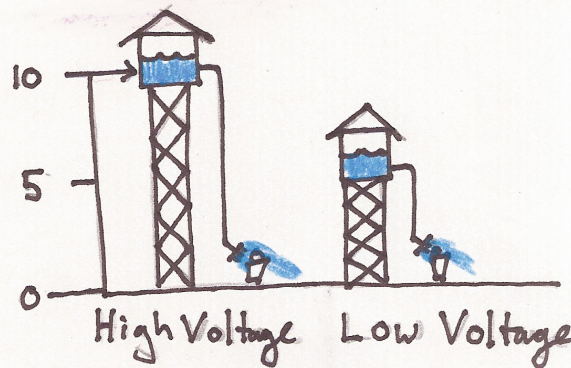

GND = GROUND  
No Electrical  
Potential.

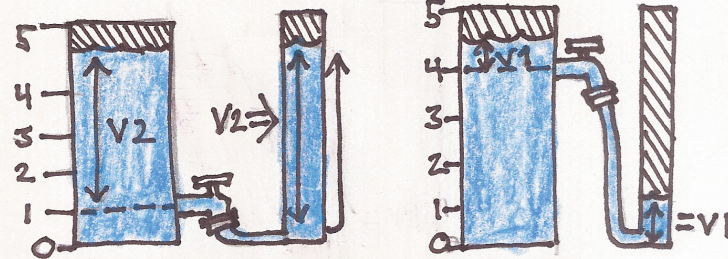

# Amperage (AMPS)

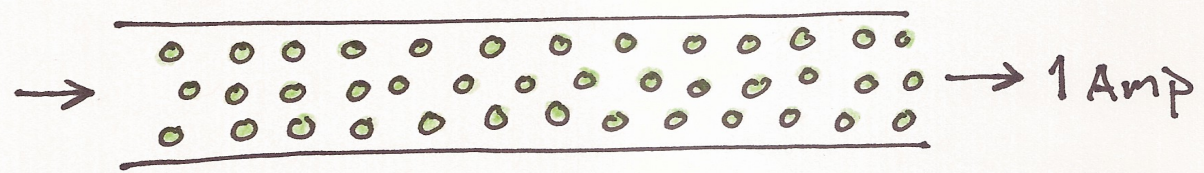
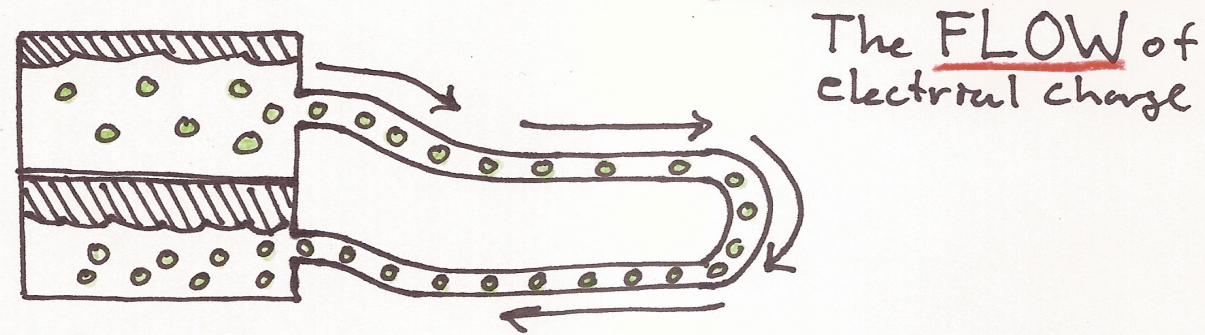
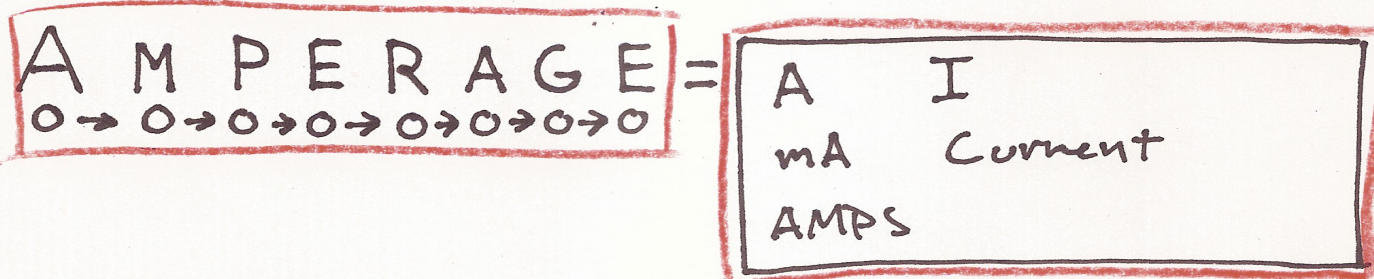

**ELECTRONS MOVE** in a **conductor** if there is a path that connects two points with a **DIFFERENCE IN VOLTAGE**:

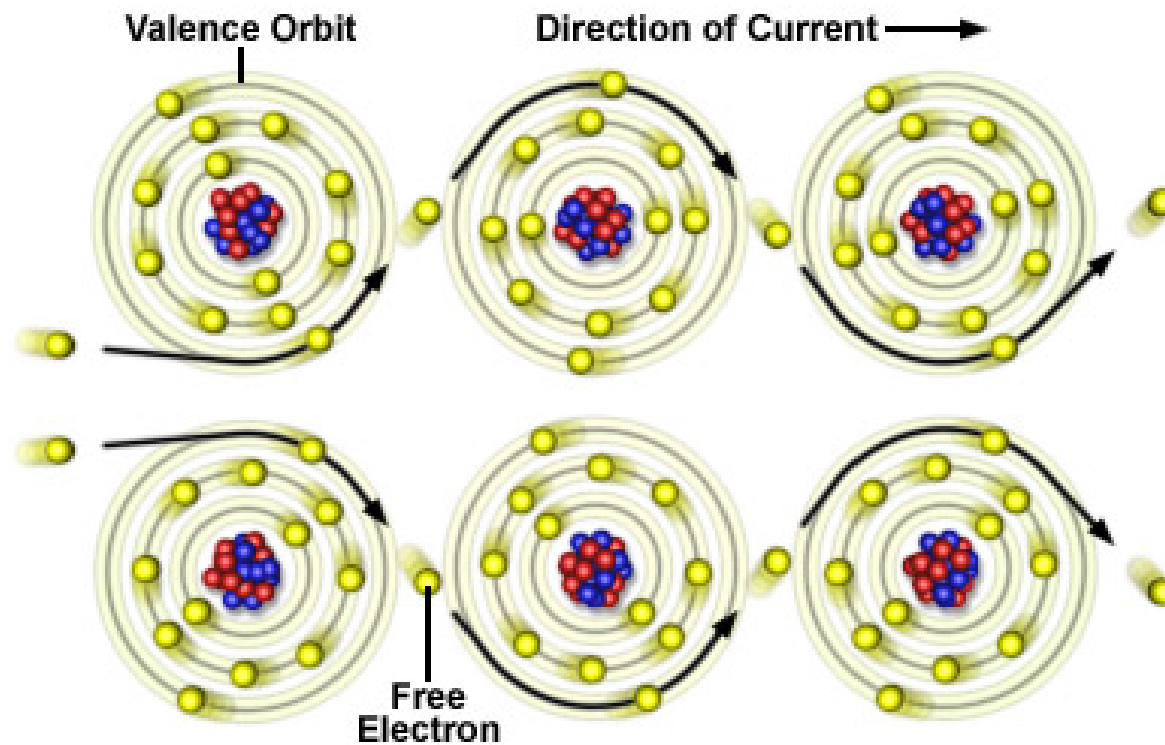

When **ELECTRONS** move in one direction this is called **DC power**.

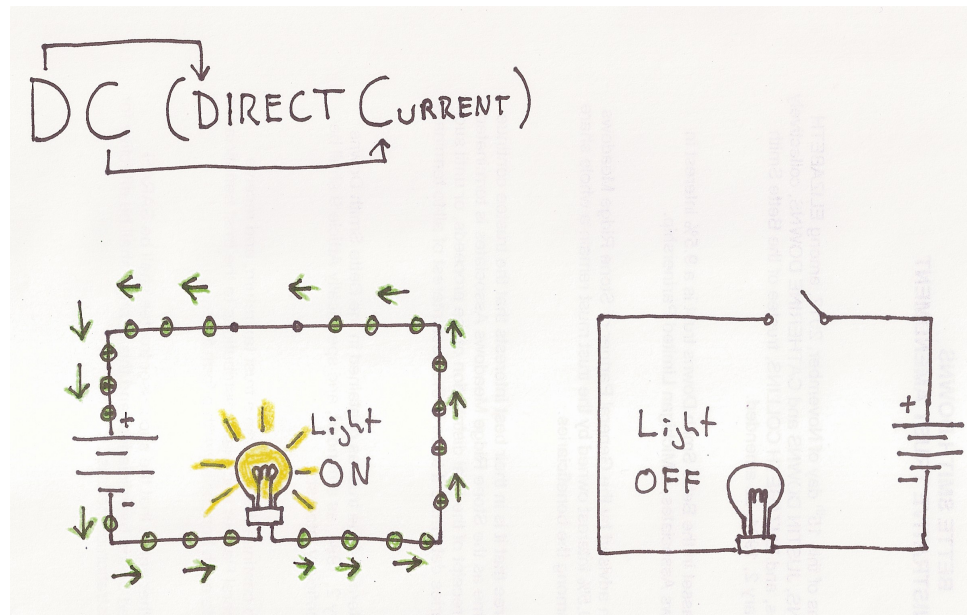
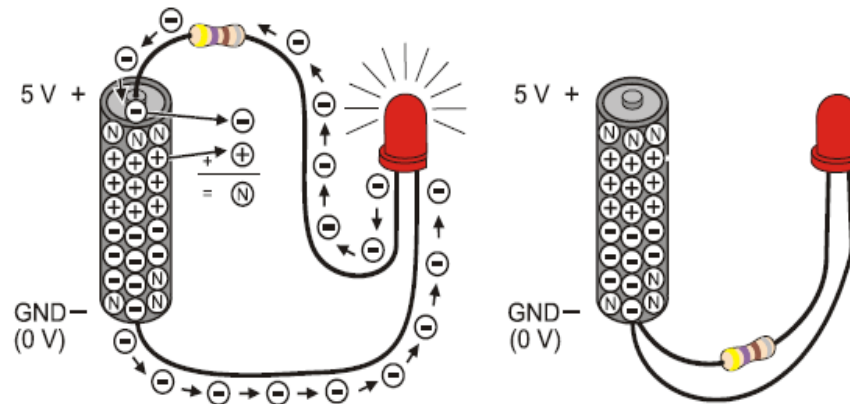

AC (alternating) power is when **ELECTRONS** flow in back and forth in **BOTH** directions:

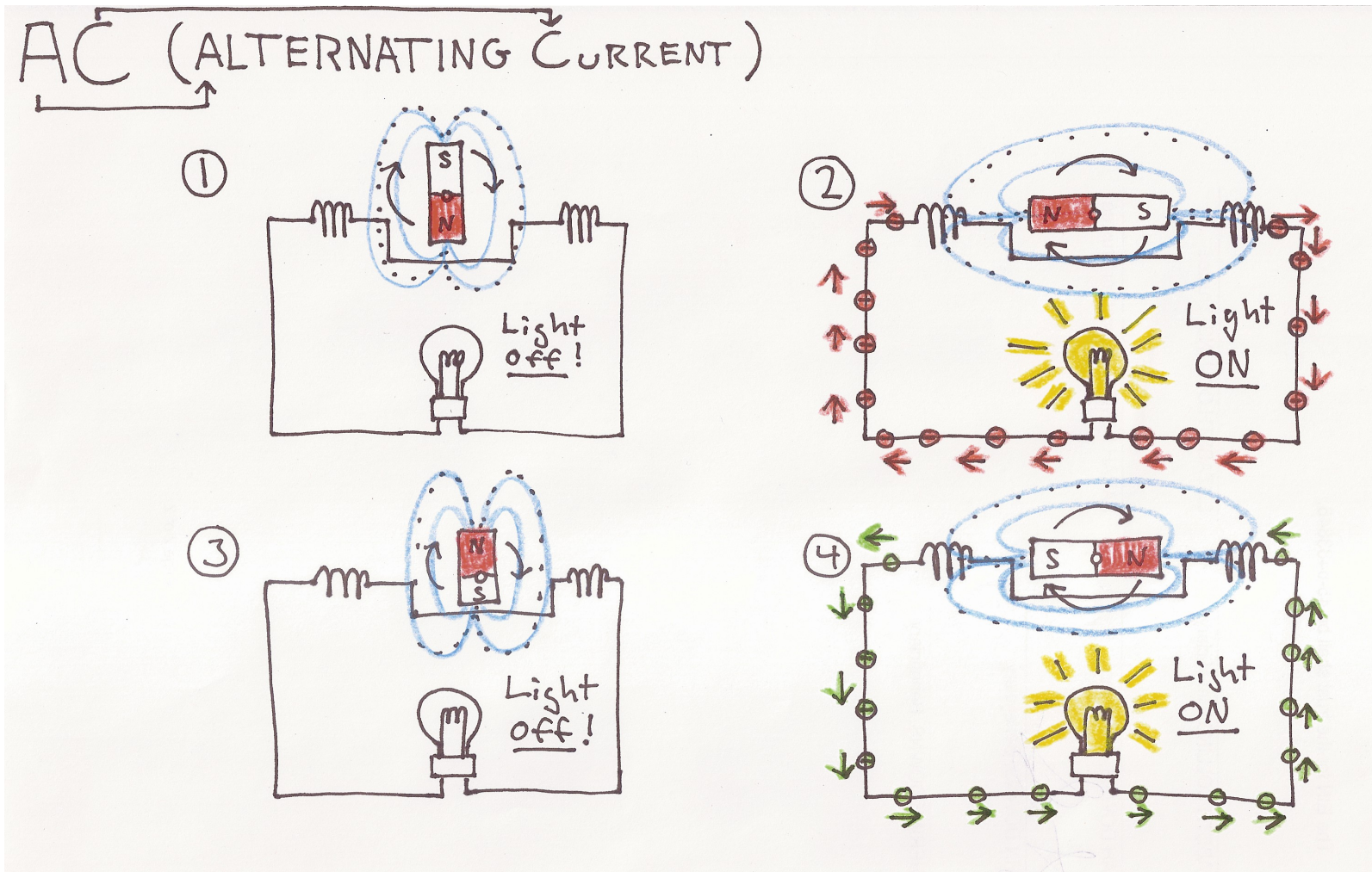



This is how **changes in voltage** are drawn.

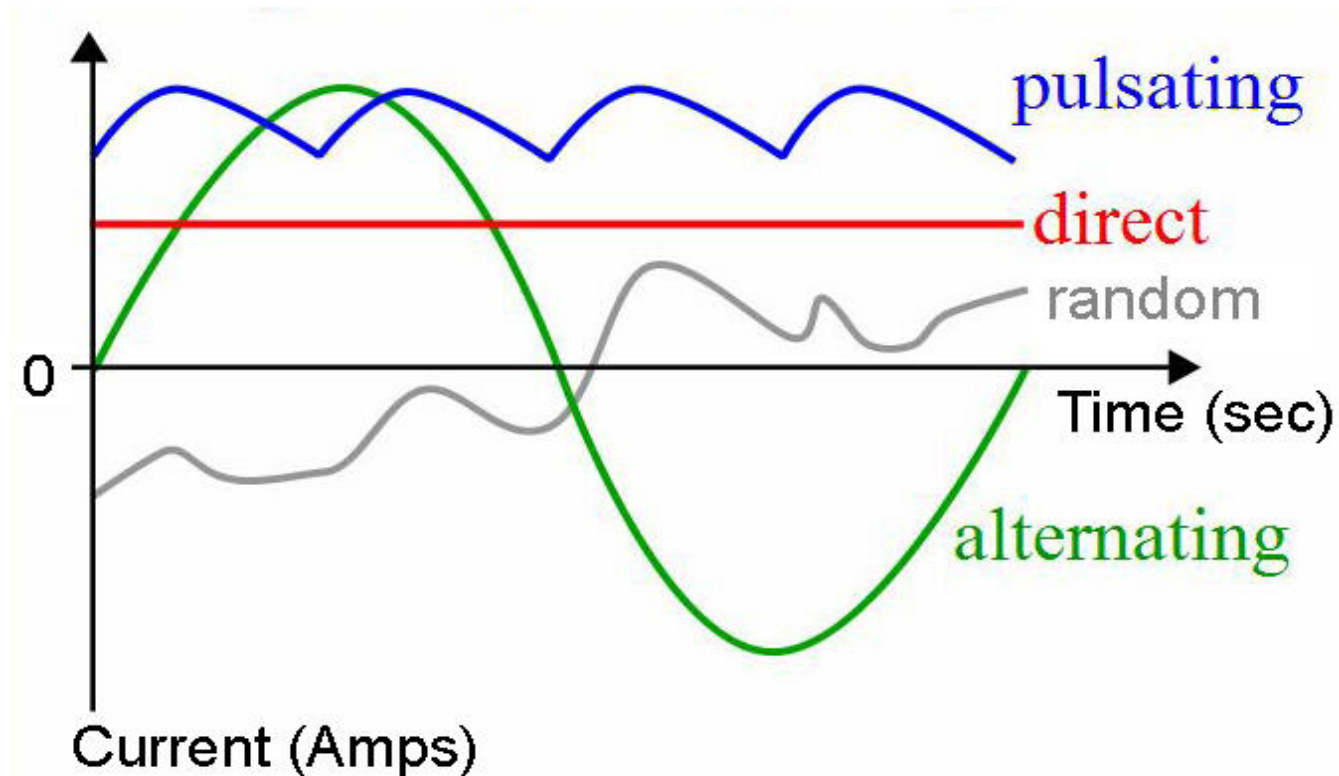

**Nikola Tesla** (10 July 1856 – 7 January 1943) Serbian immigrant.

Invented: AC electricity, wireless transmission, transformers and a lot more. He invented the modern use of electricity.

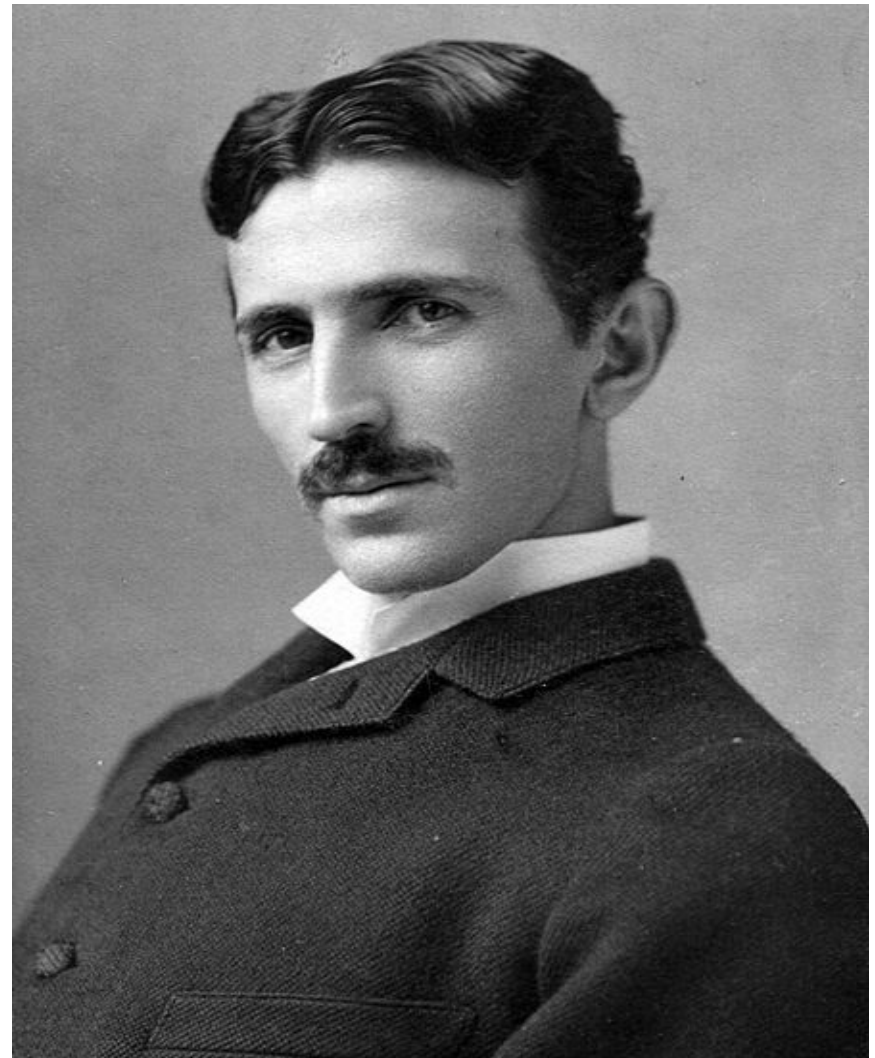

When electrons (**Amperage**) flows through a **CONDUCTOR** it creates a **MAGNETIC FIELD**.

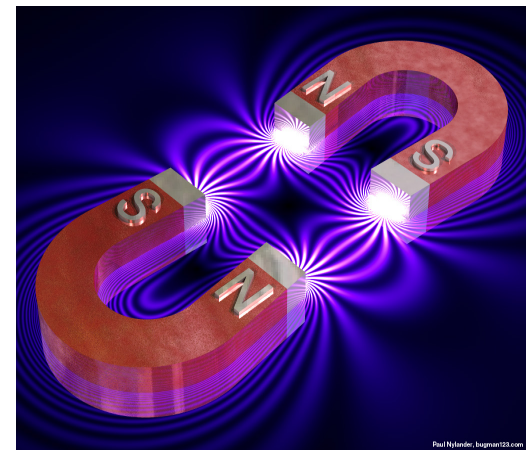
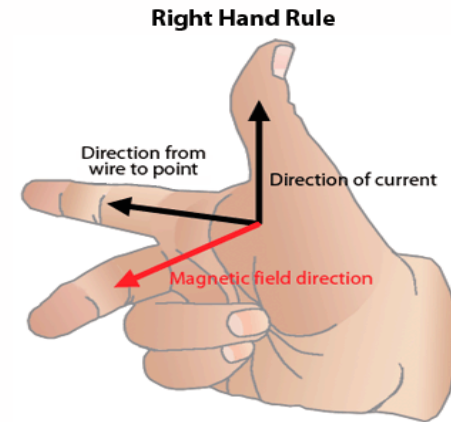
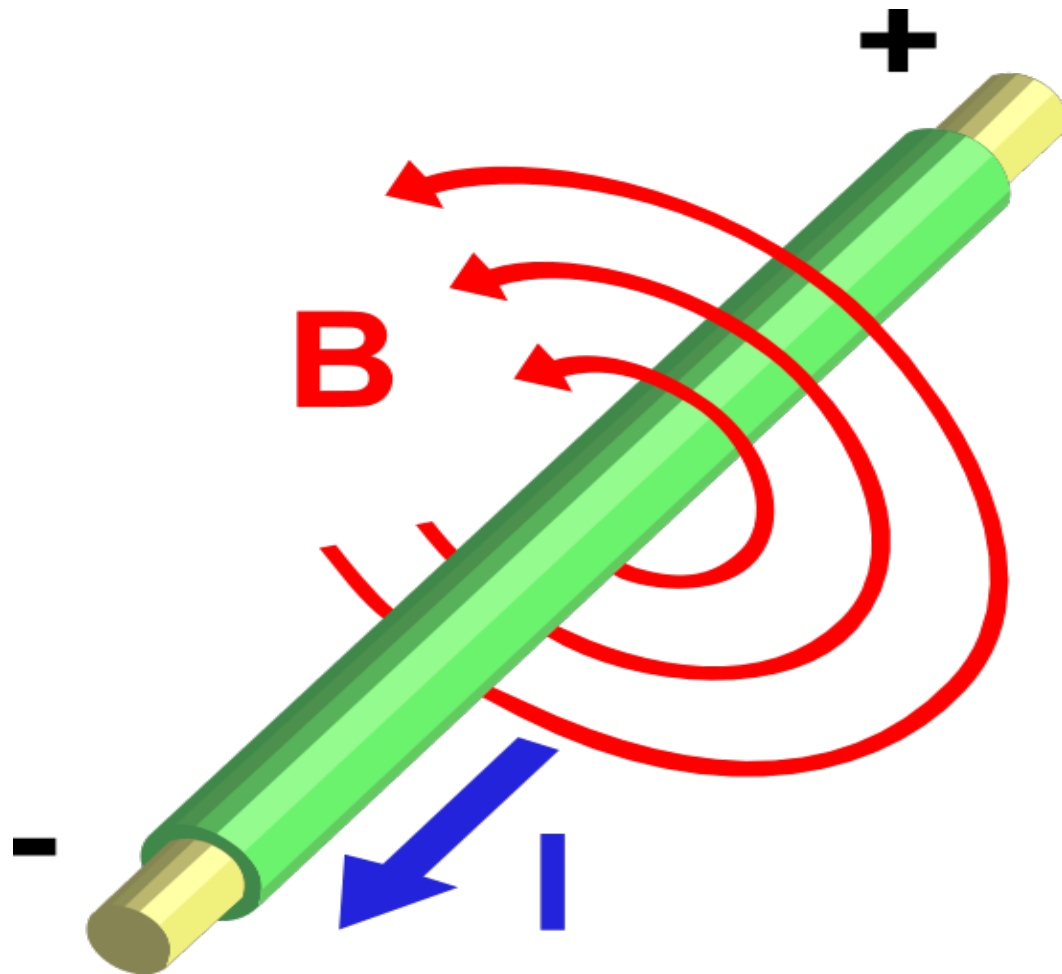

This is how a **Electromagnet** is made. It converts **electrical energy** into **kinetic energy** in the form of magnetism.

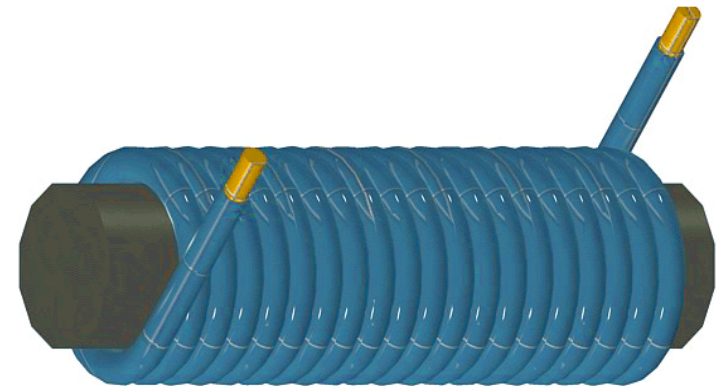
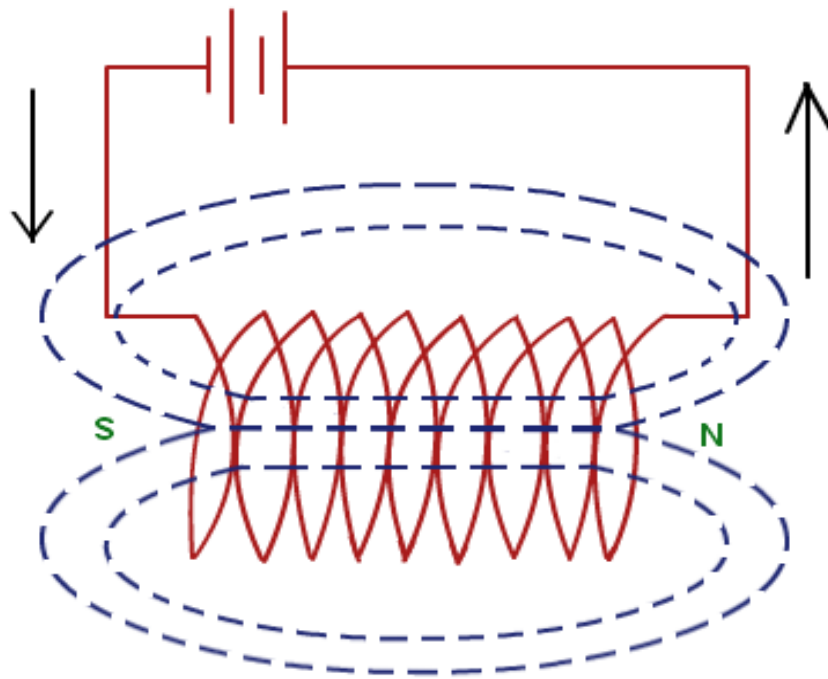

And like **Electrons** in copper, **Magnetism** or magnetic lines of flux are conducted through **Ferrous** material.

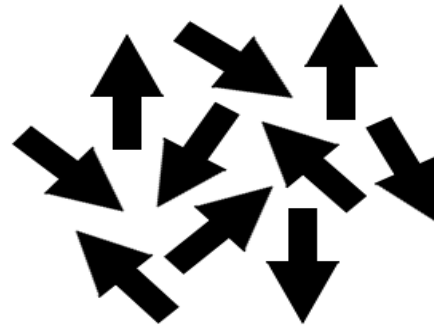
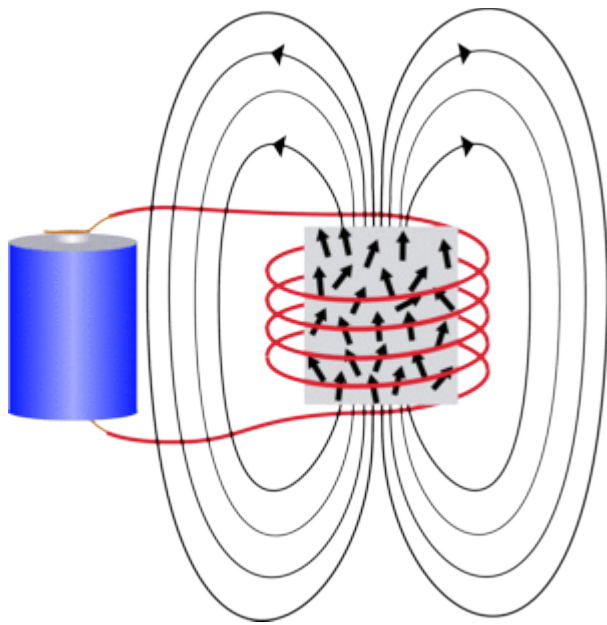

Applied Magnetic Field Absent

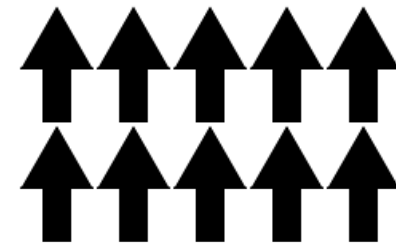

Applied Magnetic Field Present

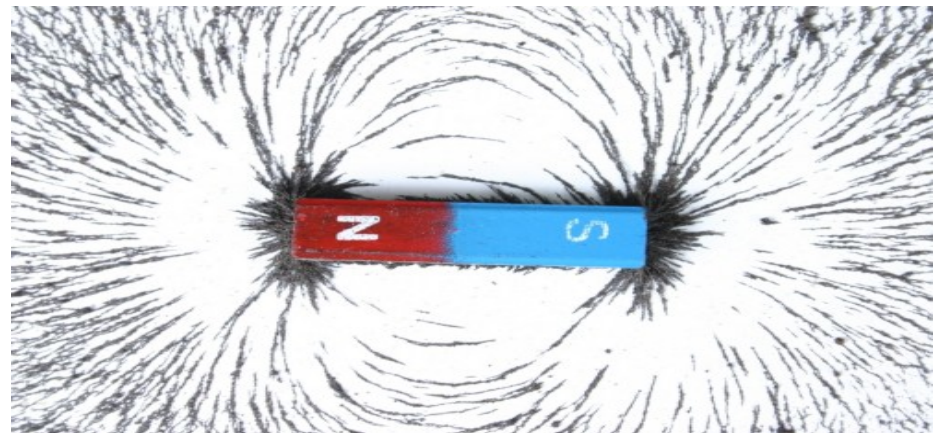

# HOW IS THIS USED FOR A RADIO BROADCAST?

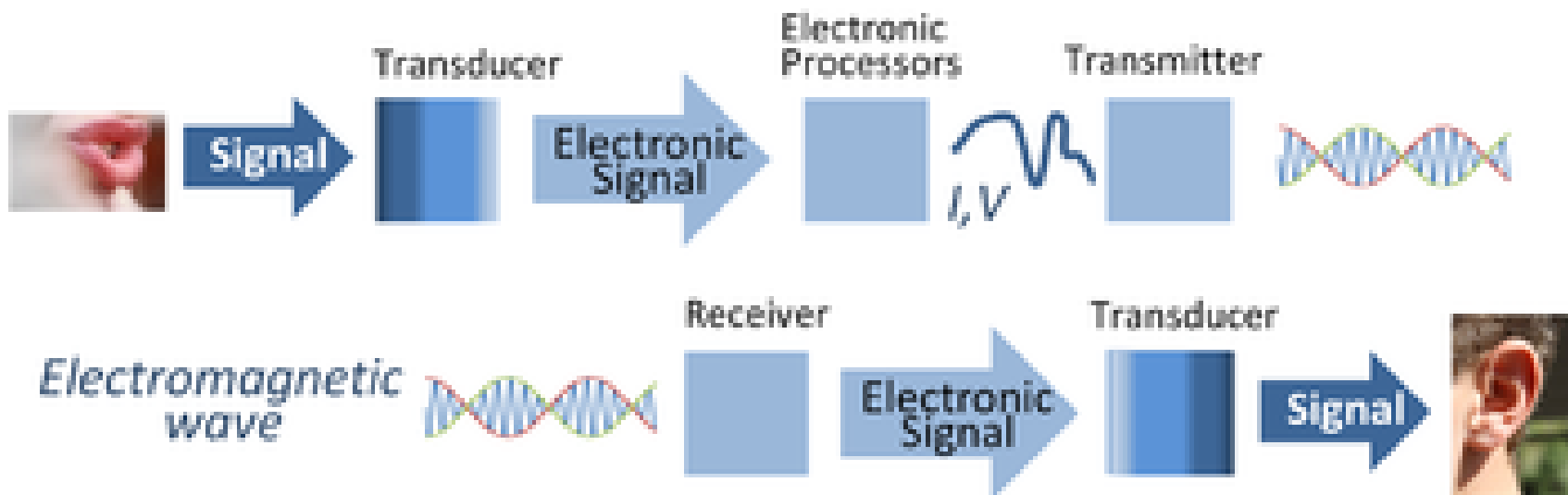
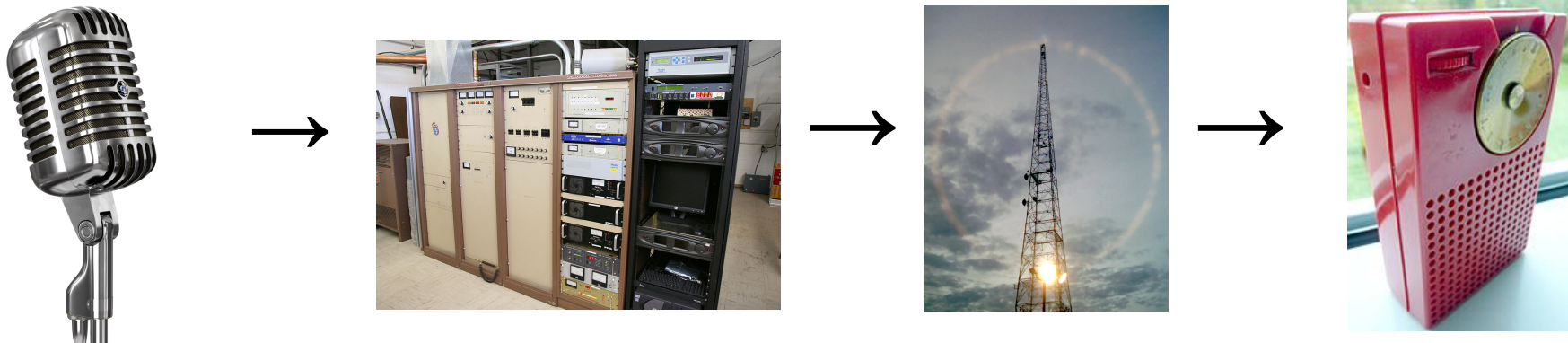

# SIGNALS

AM – Amplitude Modulated

FM – Frequency Modulated

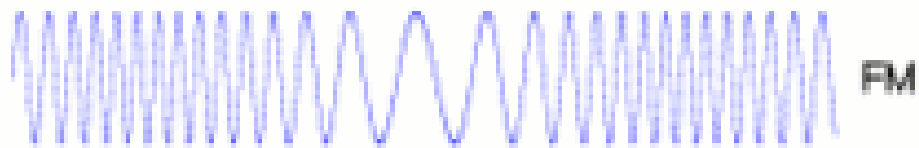
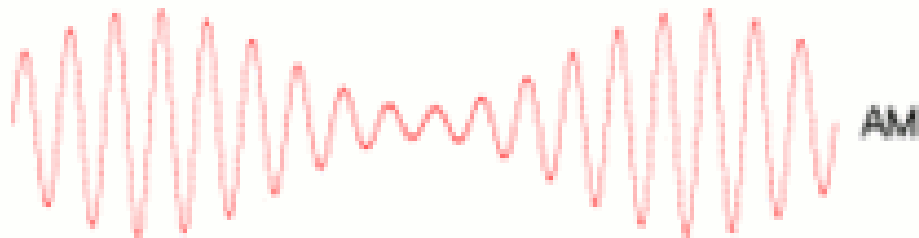

**EMF**  
**(in the air)**



# Guglielmo Marconi

Signal hill Newfoundland (Canada) December 12 1901

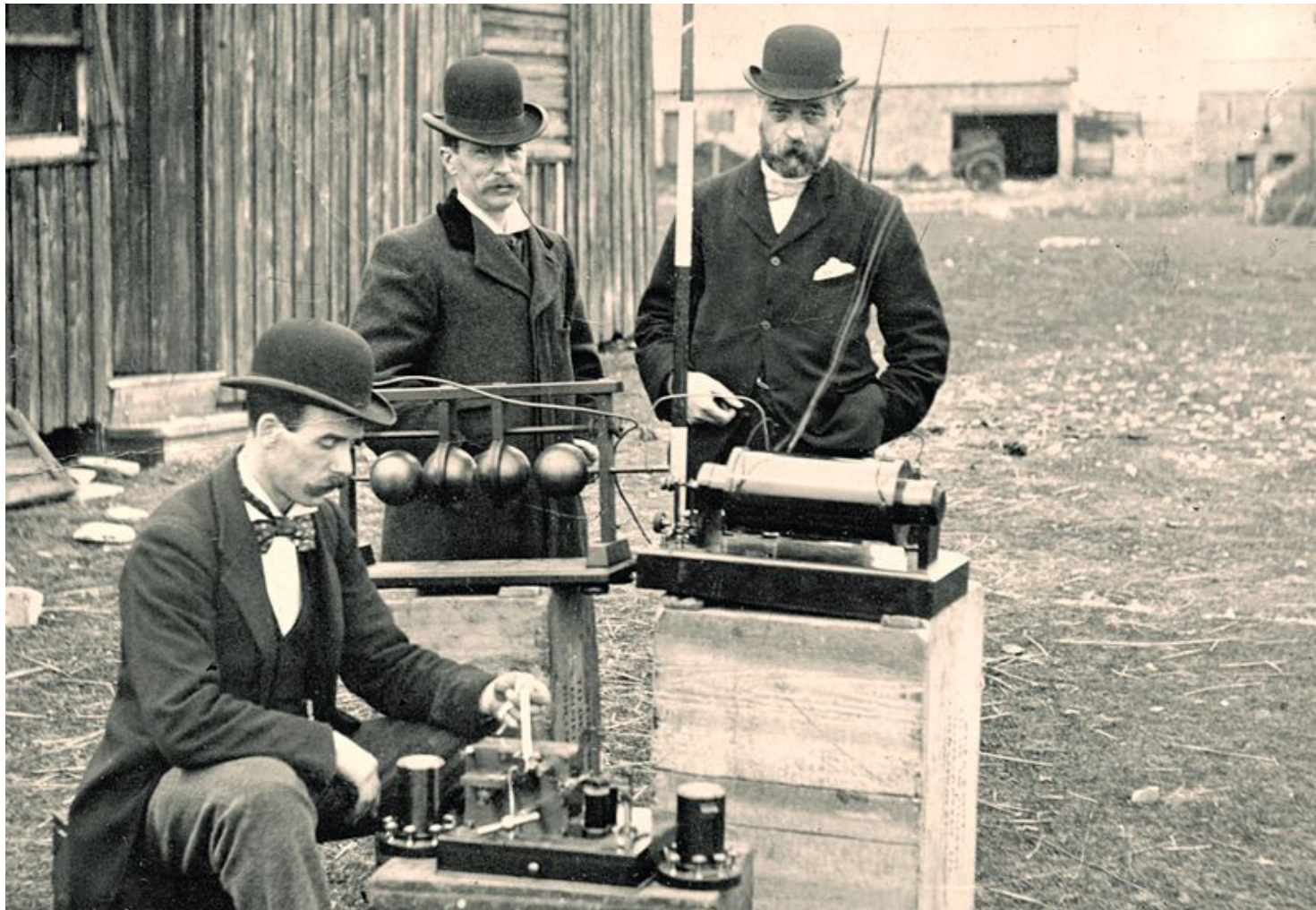



# Trans Atlantic broadcast

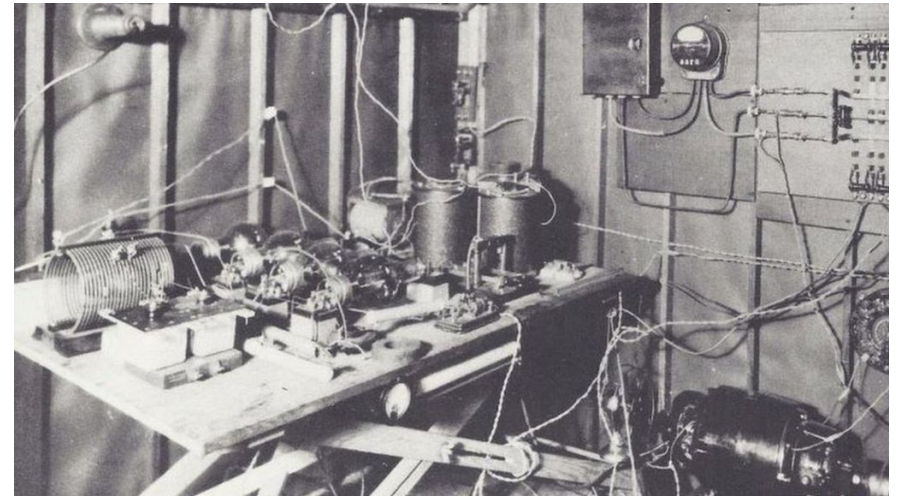
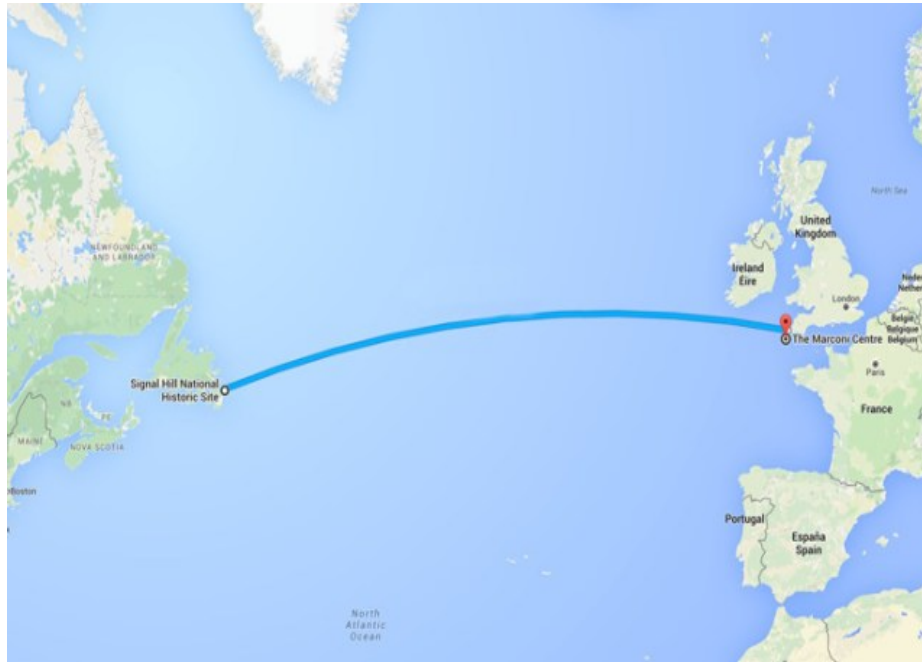

An “S” in mores code was transmitted 2,200 miles



What is a pirate?

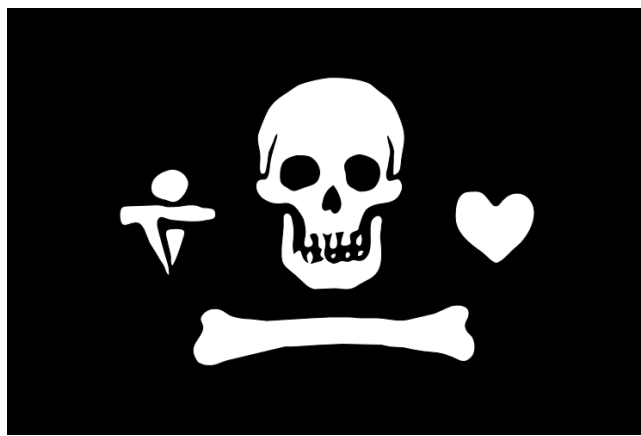

**The Republic of Pirates**  
**Nassau Bahamas 1706**

# CODE OF CONDUCT:

## Captain Bartholomew Roberts's articles (1719)

**I.** Every man has a vote in affairs of moment; has equal title to the fresh provisions, or strong liquors, at any time seized, and may use them at pleasure, unless a scarcity (not an uncommon thing among them) makes it necessary, for the good of all, to vote a retrenchment.

**II.** Every man to be called fairly in turn, by list, on board of prizes because, (over and above their proper share) they were on these occasions allowed a shift of clothes: but if they defrauded the company to the value of a dollar in plate, jewels, or money, marooning was their punishment. If the robbery was only betwixt one another, they contented themselves with slitting the ears and nose of him that was guilty, and set him on shore, not in an uninhabited place, but somewhere, where he was sure to encounter hardships.

**III.** No person to game at cards or dice for money.

**IV.** The lights and candles to be put out at eight o'clock at night: if any of the crew, after that hour still remained inclined for drinking, they were to do it on the open deck.

**V.** To keep their piece, pistols, and cutlass clean and fit for service.

**VI.** No boy or woman to be allowed amongst them. If any man were to be found seducing any of the latter sex, and carried her to sea, disguised, he was to suffer death; (so that when any fell into their hands, as it chanced in the Onslow, they put a sentinel immediately over her to prevent ill consequences from so dangerous an instrument of division and quarrel; but then here lies the roguery; they contend who shall be sentinel, which happens generally to one of the greatest bullies, who, to secure the lady's virtue, will let none lie with her but himself.)

**VII.** To desert the ship or their quarters in battle, was punished with death or marooning.

**VIII.** No striking one another on board, but every man's quarrels to be ended on shore, at sword and pistol. (The quarter-master of the ship, when the parties will not come to any reconciliation, accompanies them on shore with what assistance he thinks proper, and turns the disputant back to back, at so many paces distance; at the word of command, they turn and fire immediately (or else the piece is knocked out of their hands). If both miss, they come to their cutlasses, and then he is declared the victor who draws the first blood.)

**IX.** No man to talk of breaking up their way of living, till each had shared one thousand pounds. If in order to this, any man should lose a limb, or become a cripple in their service, he was to have eight hundred dollars, out of the public stock, and for lesser hurts, proportionately.

**X.** The [Captain](#) and [Quartermaster](#) to receive two shares of a prize: the [master](#), [boatswain](#), and [gunner](#), one share and a half, and other officers one and quarter.

**XI.** The musicians to have rest on the Sabbath Day, but the other six days and nights, none without special favour.

# SO WHAT IS PIRATE RADIO?



*Pirate radio or a pirate radio station is a radio station that broadcasts without a valid license*

REM Island was a platform off the Dutch coast used as a pirate radio station in 1964. A group of Dutch businessmen decided to establish their own station to provide a more exciting and entertaining service for viewers.

# Radio Insurgente



**Zapatistas** [[sapa'tistas](#)], are a left-wing revolutionary political and militant group based in [Chiapas](#), the southernmost state of [Mexico](#).

**Zapatistas** seek indigenous control over their local resources, especially land.

The [radio station](#) has been operating since August 2003 and it is independent from the [Mexican government](#). Its [broadcasting](#) location is unknown.

# Booger Brothers Broadcasting System, Queens, New York (circa mid-1930's to 1941).

Operated by musician Les Paul, employing the building's electrical wiring as an antenna, broadcast at night with jam sessions by jazz musicians Paul knew and played with.

